

IGBT 34mm 半桥模块

Features

- 1200V 150A
- $V_{CE(sat)(typ.)} = 1.6V @ V_{GE} = 15V, I_C = 150A$
- Soft turn off
- Positive $V_{CE(on)}$ Temperature Coefficient
- Easy paralleling

General Description

JIAEN Trench FS IGBTs offer lower losses and higher energy efficiency for general inverter and other soft switching applications. such as motor drive, AC and DC servo drive amplifier, power supply.

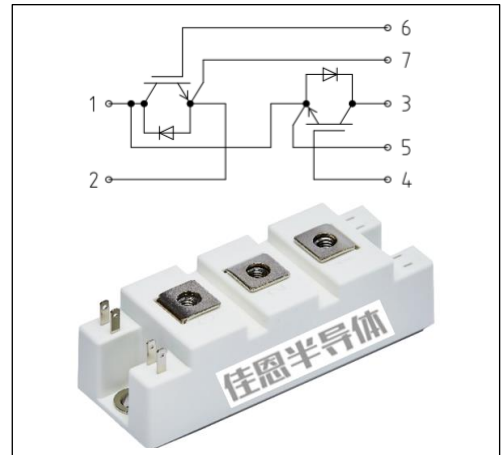

IGBT Maximum Rated Values

Symbol	Parameter	Value	Units
V_{CES}	Collector-Emitter Voltage	1200	V
V_{GES}	Gate-Emitter Voltage	± 20	V
I_C	Continuous Collector Current ($T_C=70^\circ C, T_{vj\ max}=150^\circ C$)	150	A
I_{CRM}	Repetitive Peak Collector Current ($tp= 1\ ms$)	300	A
P_D	Maximum Power Dissipation ($T_C=25^\circ C, T_{vj\ max}=150^\circ C$)	658	W

IGBT Characteristics

Symbol	Parameter	Test Condition	Min	Typ	Max	Units
$V_{CE(sat)}$	Collector-Emitter Saturation Voltage	$V_{GE}=15V, I_C=150A$ $T_{vj}=25^\circ C$	-	1.6	1.9	V
	Collector-Emitter Saturation Voltage	$V_{GE}=15V, I_C=150A$ $T_{vj}=150^\circ C$	-	1.9	-	V
$V_{GE(th)}$	Gate Threshold Voltage	$V_{GE}=V_{CE}, I_C=5.7mA$	5.0	5.8	6.6	V
Q_g	Total Gate Charge	$V_{GE}=-15V \dots +15V$	-	1.05	-	μC
C_{ies}	Input Capacitance	$V_{CE}=25V$ $V_{GE}=0V$ $f=100KHz$	-	29.8	-	nF
C_{oes}	Output Capacitance		-	0.78	-	nF
C_{res}	Reverse Transfer Capacitance		-	0.24	-	nF
I_{CES}	Collector-Emitter Leakage Current	$V_{CE}=1200V, V_{GE}=0V$	-	-	1.0	mA
I_{GES}	Gate Leakage Current, Forward	$V_{GE}=20V, V_{CE}=0V$	-	-	200	nA
	Gate Leakage Current, Reverse	$V_{GE}=-20V, V_{CE}=0V$	-	-	-200	nA

$t_{d(on)}$	Turn-on Delay Time	$V_{CC}=600V$ $V_{GE}=\pm 15V$ $I_C=150A$ $R_G=3\Omega$ Inductive Load $T_{vj}=25^\circ C$	-	139	-	ns
t_r	Turn-on Rise Time		-	67	-	ns
$t_{d(off)}$	Turn-off Delay Time		-	301	-	ns
t_f	Turn-off Fall Time		-	274	-	ns
Eon	Turn-on Switching Loss		-	4.4	-	mJ
Eoff	Turn-off Switching Loss		-	12.3	-	mJ
Ets	Total Switching Loss	-	16.7	-	mJ	
$t_{d(on)}$	Turn-on Delay Time	$V_{CC}=600V$ $V_{GE}=\pm 15V$ $I_C=150A$ $R_G=3\Omega$ Inductive Load $T_{vj}=125^\circ C$	-	161	-	ns
t_r	Turn-on Rise Time		-	73	-	ns
$t_{d(off)}$	Turn-off Delay Time		-	325	-	ns
t_f	Turn-off Fall Time		-	406	-	ns
Eon	Turn-on Switching Loss		-	7.0	-	mJ
Eoff	Turn-off Switching Loss		-	16.7	-	mJ
Ets	Total Switching Loss	-	23.7	-	mJ	
$t_{d(on)}$	Turn-on Delay Time	$V_{CC}=600V$ $V_{GE}=\pm 15V$ $I_C=150A$ $R_G=3\Omega$ Inductive Load $T_{vj}=150^\circ C$	-	169	-	ns
t_r	Turn-on Rise Time		-	73	-	ns
$t_{d(off)}$	Turn-off Delay Time		-	333	-	ns
t_f	Turn-off Fall Time		-	434	-	ns
Eon	Turn-on Switching Loss		-	7.8	-	mJ
Eoff	Turn-off Switching Loss		-	17.8	-	mJ
Ets	Total Switching Loss	-	25.6	-	mJ	
Isc	Short circuit current	$V_{GE}=15V, T_p \leq 10\mu s$ $T_{vj}=150^\circ C, V_{CC}=600V$ $V_{CEM\ Chip} \leq 1200V$	-	500	-	A
$R_{th\ j-c}$	Thermal resistance, junction to case		-	-	0.19	K/W
$T_{vj\ op}$	Temperature under switching condition		-40	-	150	$^\circ C$

Diode Maximum Rated Values

Symbol	Parameter	Value	Units
V _{RRM}	Repetitive peak reverse voltage	1200	V
I _F	Continuous DC Forward Current	150	A
I _{FRM}	Repetitive Peak Collector Current (tp= 1ms)	300	A

Diode Characteristics

Symbol	Parameter	Test Conditions	Min.	Typ.	Max.	Units
V _F	Diode Forward Voltage	I _F =150A V _{GE} =0V T _{vj} =25°C	-	2.7	3.2	V
		I _F =150A V _{GE} =0V T _{vj} =150°C	-	1.9	-	V
I _{RM}	Peak reverse recovery current	I _C =150A V _R =600V -di/dt=2500A/us V _{GE} =±15V T _{vj} =25°C	-	98	-	A
Q _{rr}	Diode Reverse Recovery Charge		-	6.0	-	µC
E _{rec}	Reverse recovery energy		-	5.1	-	mJ
I _{RM}	Peak reverse recovery current	I _C =150A V _R =600V -di/dt=2500A/us V _{GE} =±15V T _{vj} =125°C	-	154	-	A
Q _{rr}	Diode Reverse Recovery Charge		-	15.5	-	µC
E _{rec}	Reverse recovery energy		-	9.9	-	mJ
I _{RM}	Peak reverse recovery current	I _C =150A V _R =600V -di/dt=2500A/us V _{GE} =±15V T _{vj} =150°C	-	170	-	A
Q _{rr}	Diode Reverse Recovery Charge		-	19.4	-	µC
E _{rec}	Reverse recovery energy		-	11.5	-	mJ
R _{th j-c}	Thermal resistance, junction to case		-	-	0.31	K/W
T _{vj op}	Temperature under switching condition		-40	-	150	°C

Module

Isolation test voltage	RMS, f=50 Hz, t=1 min	V _{ISOL}	4.0	kV
Material of module baseplate			Cu	
Internal isolation	basic insulation (class 1, IEC 61140)		Al ₂ O ₃	
Clearance distance in air	Terminal to terminal		9.5	mm
Surface creepage distance	Terminal to terminal		20	mm
Comperative tracking index		CTI	>200	
Storage temperature		T _{stg}	-40~150	°C
Mounting torque for module mounting	M6 screws	M	3~5	Nm

Notes:

1. Repetitive Rating: Pulse width limited by maximum junction temperature

Typical Performance Characteristics

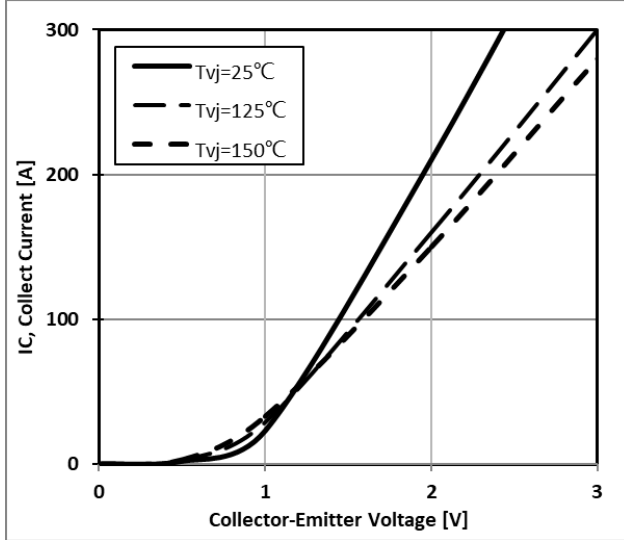

Figure 1: IGBT output characteristics (typical)

$$I_C = f(V_{CE}) \quad V_{GE} = 15\text{V}$$

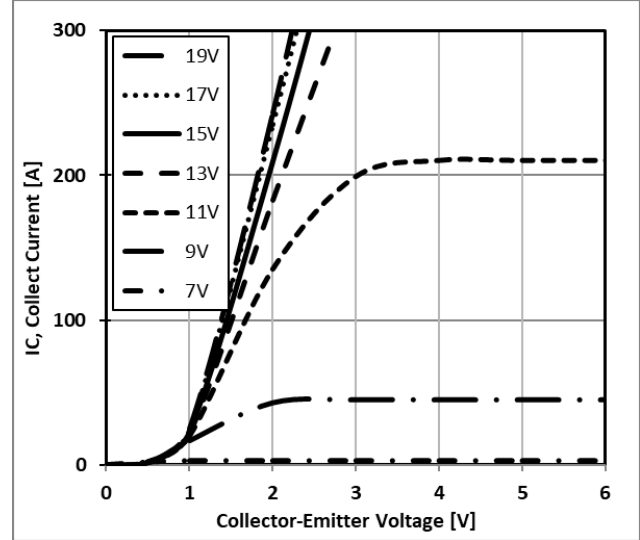

Figure 2: IGBT output characteristics (typical)

$$I_C = f(V_{CE}) \quad T_{vj} = 25^\circ\text{C}$$

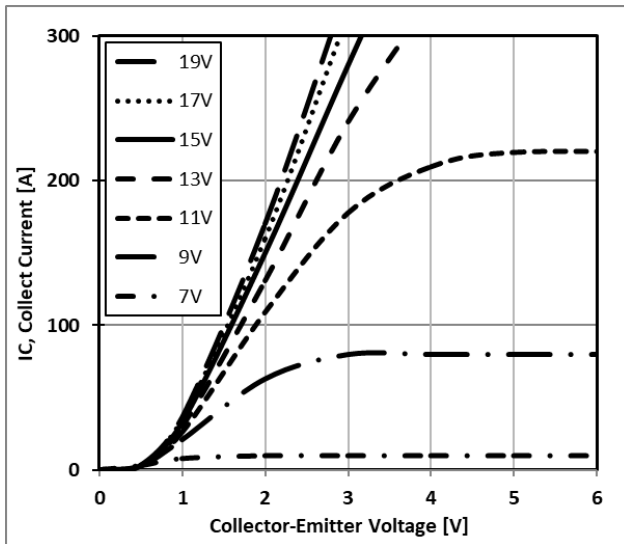

Figure 3: IGBT output characteristics (typical)

$$I_C = f(V_{CE}) \quad T_{vj} = 150^\circ\text{C}$$

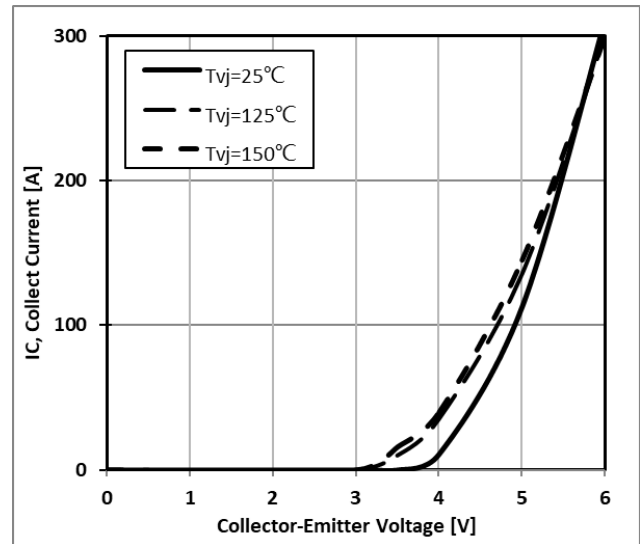

Figure 4: IGBT transfer characteristics (typical)

$$I_C = f(V_{GE}) \quad V_{CE} = V_{GE}$$

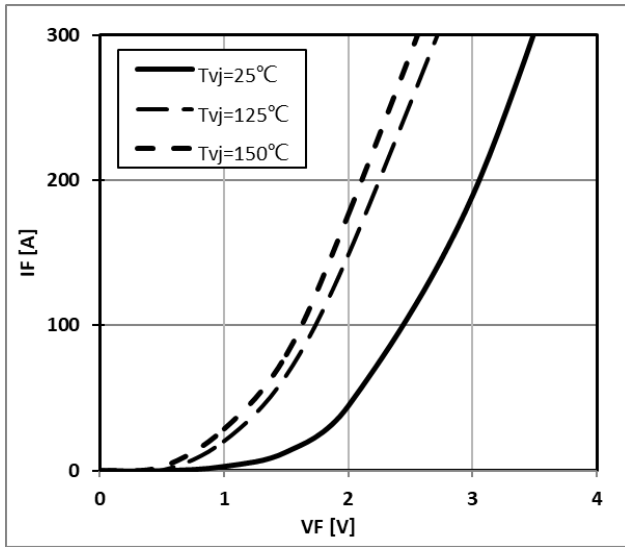

Figure 5: Diode forward characteristic (typical)

$$I_F = f(V_F)$$

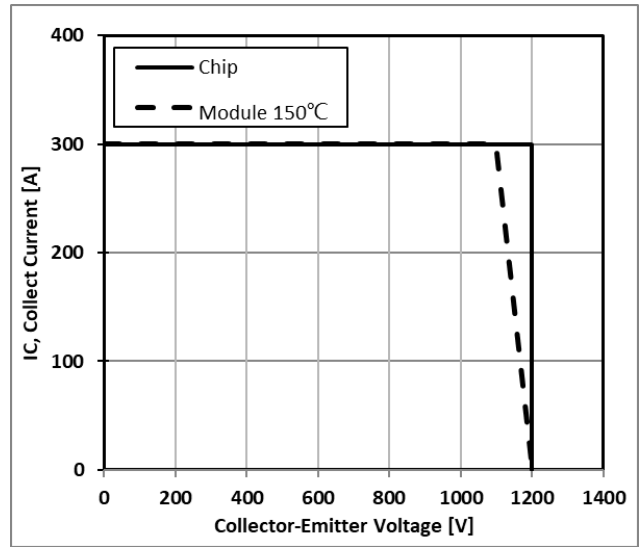

Figure 6: IGBT RBSOA

$$I_C = f(V_{CEm}) \quad R_{goff} = 8 \Omega, \quad V_{GE} = \pm 15V$$

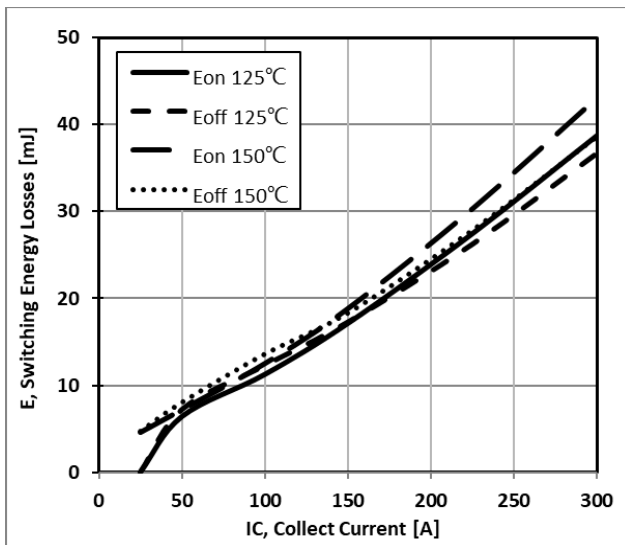

Figure 7: IGBT switching losses (typical)

$$E = f(I_{CE})$$

$$V_{CE} = 600V, \quad R_{Gon} = 8 \Omega, \quad R_{Goff} = 8 \Omega, \quad V_{GE} = \pm 15V$$

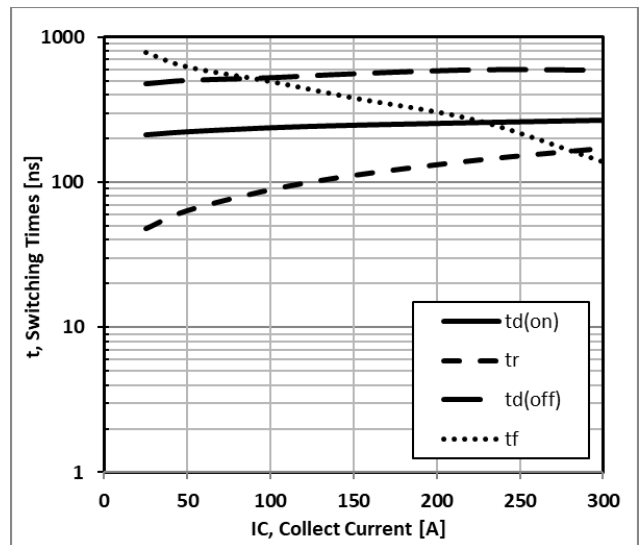

Figure 8: IGBT switching times (typical)

$$t = f(I_{CE}) \quad T_{vj} = 150^\circ C$$

$$V_{CE} = 600V, \quad R_{Gon} = 8 \Omega, \quad R_{Goff} = 8 \Omega, \quad V_{GE} = \pm 15V$$

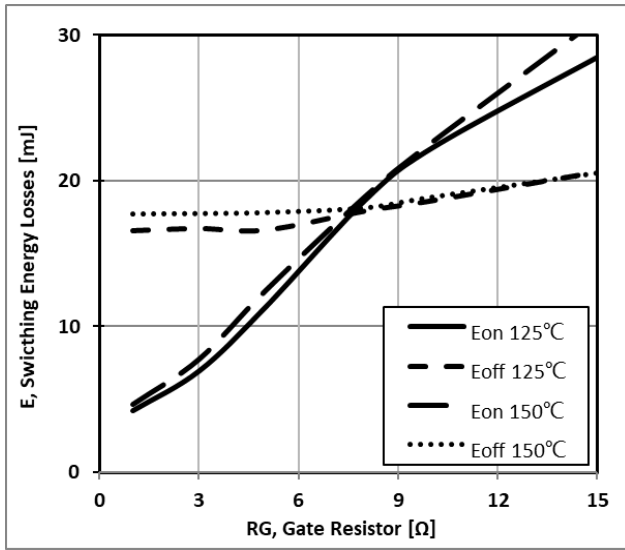

Figure 9: IGBT switching losses (typical)

$$E = f(R_G)$$

$V_{CE}=600V, I_C=150A, V_{GE}=\pm 15V$

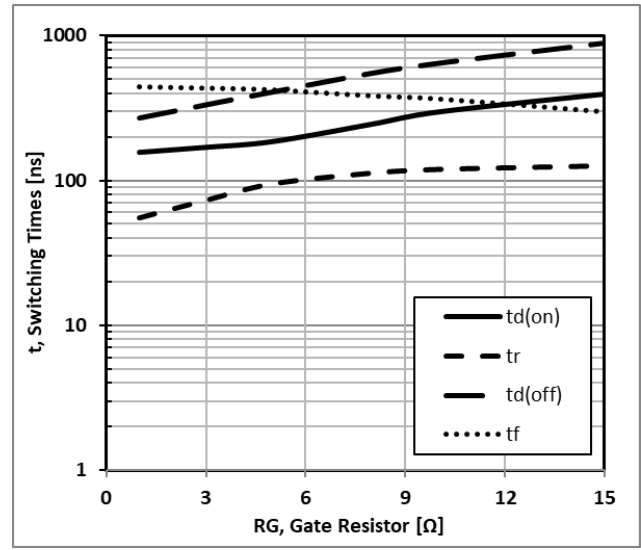

Figure 10: IGBT switching times (typical)

$$t = f(R_G) \quad T_{vj}=150^\circ C$$

$V_{CE}=600V, I_C=150A, V_{GE}=\pm 15V$

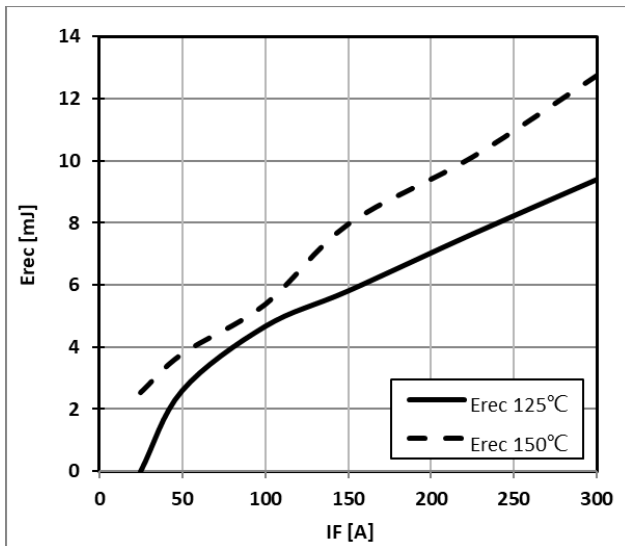

Figure 11: Diode switching characteristics (typical)

$$E_{REC} = f(I_F)$$

$V_{DC}=600V, R_{Gon}=8 \Omega \text{ (IGBT)}, V_{GE}=\pm 15V \text{ (IGBT)}$

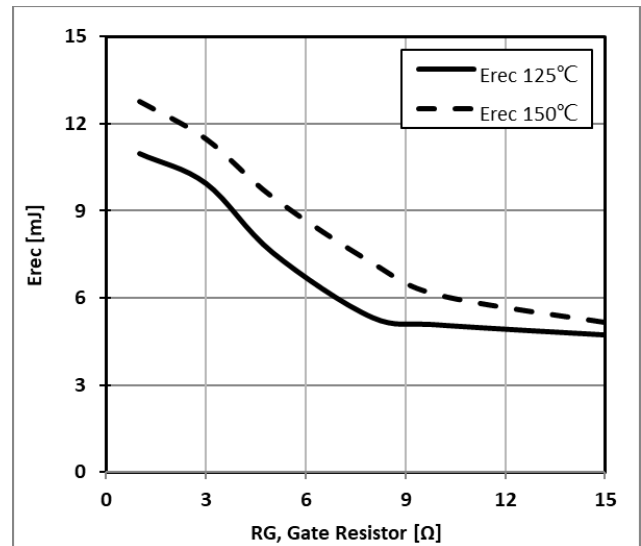

Figure 12: Diode switching characteristics (typical)

$$E_{REC} = f(R_G)$$

$V_{DC}=600V, I_F=150A, V_{GE}=\pm 15V \text{ (IGBT)}$

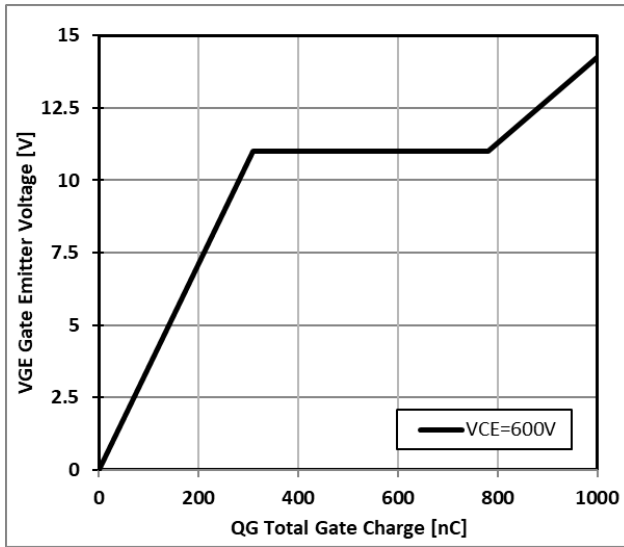

Figure 13: IGBT gate charge (typical)

$$V_{GE}=f(Q_G) \quad T_{vj}=25^{\circ}\text{C}$$

$$V_{CE}=600\text{V}, I_C=150\text{A}$$

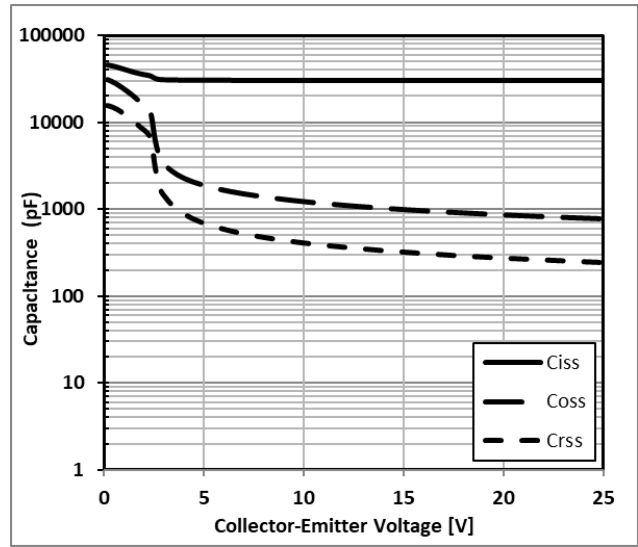

Figure 14: Capacitance characteristics (typical)

$$C=f(V_{CE}) \quad T_{vj}=25^{\circ}\text{C}$$

$$f=100\text{KHz}, V_{GE}=0\text{V}$$

Disclaimers

JIAEN Semiconductor Co., Ltd reserves the right to make changes without notice in order to improve reliability, function or design and to discontinue any product or service without notice. Customers should obtain the latest relevant information before orders and should verify that such information is current and complete. All products are sold subject to JIAEN's terms and conditions supplied at the time of order acknowledgement.

JIAEN Semiconductor Co., Ltd warrants performance of its hardware products to the specifications at the time of sale, Testing, reliability and quality control are used to the extent JIAEN deems necessary to support this warrantee. Except where agreed upon by contractual agreement, testing of all parameters of each product is not necessarily performed.

JIAEN Semiconductor Co., Ltd does not assume any liability arising from the use of any product or circuit designs described herein. Customers are responsible for their products and applications using JIAEN's components. To minimize risk, customers must provide adequate design and operating safeguards.

JIAEN Semiconductor Co., Ltd does not warrant or convey any license either expressed or implied under its parent rights, nor the rights of others. Reproduction of information in JIAEN's datasheets or data books is permissible only if reproduction is without modification or alteration. Reproduction of this information with any alteration is an unfair and deceptive business practice. JIAEN Semiconductor Co., Ltd is not responsible or liable for such altered documentation.

Resale of JIAEN's products with statements different from or beyond the parameters stated by JIAEN Semiconductor Co., Ltd for that product or service voids all express or implied warranties for the associated JIAEN's product or service and is unfair and deceptive business practice. JIAEN Semiconductor Co., Ltd is not responsible or liable for any such statements.