

600V N-Channel MOSFET

General Description

This Power MOSFET is produced using advanced planar stripe DMOS technology. This advanced technology has been especially tailored to minimize on-state resistance, provide superior switching performance, and withstand high energy pulse in the avalanche and commutation mode. These devices are well suited for high efficiency switched mode power supplies, active power factor correction based on half bridge topology.

Features

- 7A, 600V, $R_{DS(on)typ.} = 1.2\Omega @ V_{GS} = 10V$
- Low gate charge
- High ruggedness
- Fast switching
- Improved dv/dt capability

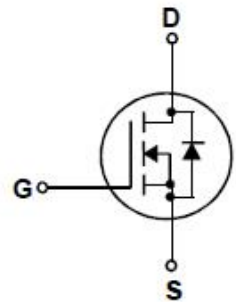
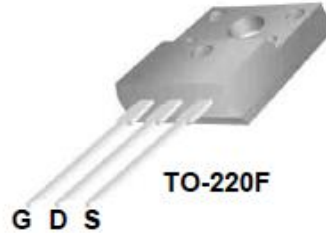
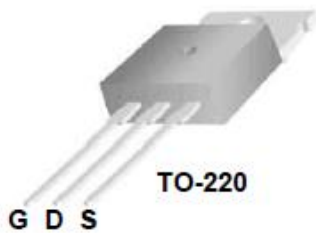

Absolute Maximum Ratings $T_c = 25^\circ\text{C}$ unless otherwise noted

Symbol	Parameter	JFPC7N60C	JFFM7N60C	Units
V_{DSS}	Drain – Source Voltage	600		V
I_D	Drain Current	Continuous ($T_c = 25^\circ\text{C}$)	7	7*
		Continuous ($T_c = 100^\circ\text{C}$)	4.5	4.5
I_{CM}	Drain Current - Pulsed (Note 1)	30		A
V_{GSS}	Gate – Source Voltage	± 30		V
EAS	Single Pulsed Avalanche Energy (Note 2)	119		mJ
I_{AR}	Avalanche Current (Note 1)	7		A
E_{AR}	Repetitive Avalanche Energy (Note 1)	19.2		mJ
dv/dt	Peak Diode Recovery dv/dt (Note 3)	4.5		V/ns
P_D	Power Dissipation ($T_c = 25^\circ\text{C}$) -Derate above 25°C	192	40	W
		1.53	0.32	W/ $^\circ\text{C}$
T_J, T_{STG}	Operating and Storage Temperature Range	-55 to +150		$^\circ\text{C}$
T_L	Maximum lead temperature for soldering purposes 1/8" from case for 5 seconds	300		$^\circ\text{C}$

*Drain current limited by maximum junction temperature.

Thermal characteristics

Symbol	Parameter	JFPC7N60C	JFFM7N60C	Units
R _{θJC}	Thermal Resistance, Junction-to-Case	0.65	3.15	°C/W
R _{θJS}	Thermal Resistance, Case-to-Sink Typ.	0.5	--	°C/W
R _{θJA}	Thermal Resistance, Junction-to-Ambient	62.5	62.5	°C/W

Electrical Characteristics T_c = 25 °C unless otherwise noted

Symbol	Parameter	Test Conditions	Min	Typ	Max	Units
Off Characteristics						
BV _{DSS}	Drain – Source Breakdown Voltage	V _{GS} = 0 V, I _D = 250 uA	600	--	--	V
ΔBV _{DSS} /ΔT _J	Breakdown Voltage Temperature Coefficient	I _D = 250 uA, Referenced to 25°C	--	0.6	--	V/°C
I _{DSS}	Zero Gate Voltage Drain Current	V _{DS} = 600 V, V _{GS} = 0 V	--	--	1	uA
		V _{DS} = 480 V, T _c = 125 °C	--	--	10	uA
I _{GSSF}	Gate-Body Leakage Current, Forward	V _{GS} = 30 V, V _{DS} = 0 V	--	--	100	nA
I _{GSSR}	Gate-Body Leakage Current, Reverse	V _{GS} = -30 V, V _{DS} = 0 V	--	--	-100	nA
On Characteristics						
V _{GS(th)}	Gate Threshold Voltage	V _{DS} = V _{GS} , I _D = 250 uA	2.0	--	4.0	V
R _{DS(on)}	Static Drain-Source on-Resistance	V _{GS} = 10V, I _D = 3.5	--	1.2	1.6	Ω
g _{FS}	Forward Transconductance	V _{DS} = 40 V, I _D = 3.5A Note 4)	--	6.8	--	S
Dynamic Characteristics						
C _{iss}	Input Capacitance	V _{DS} = 25 V, V _{GS} = 0 V, f = 1.0 MHz	--	1121	--	pF
C _{oss}	Output Capacitance		--	96	--	pF
C _{rss}	Reverse Transfer Capacitance		--	5.5	--	pF
Switching Characteristics						
t _{d(on)}	Turn-On Delay Time	V _{DS} = 300 V, I _D = 3.5A V _{GS} = 10 V, R _G = 25Ω (Note 4,5)	--	18	--	ns
t _r	Turn-On Rise Time		--	22	--	ns
t _{d(off)}	Turn-Off Delay Time		--	40	--	ns
t _f	Turn-Off Fall Time		--	19	--	ns
Q _g	Total Gate Charge	V _{DS} = 300 V, I _D = 7. A V _{GS} = 10 V (Note 4,5)	--	24	--	nC
Q _{gs}	Gate-Source Charge		--	5.1	--	nC
Q _{gd}	Gate-Drain Charge		--	9.5	--	nC
Drain – Source Diode Characteristics and Maximum Ratings						
I _S	Maximum Continuous Drain-Source Diode Forward Current		--	--	7	A
I _{SM}	Maximum Pulsed Drain-Source Diode Forward Current		--	--	30	A
V _{SD}	Drain-Source Diode Forward Voltage	V _{GS} = 0 V, I _S = 7 A	--	--	1.4	V
t _{rr}	Reverse Recovery Time	V _{GS} = 0 V, I _S = 7 A	--	363	--	ns
Q _{rr}	Reverse Recovery Charge	dI _F /dt = 100 A/us (Note 4)	--	1.92	--	uC

Notes:

1. Repetitive Rating : Pulsed width limited by maximum junction temperature
2. L = 3mH , I_{AS} = 7.5A V_{DD} = 50V, R_G = 25Ω, Starting T_J = 25°C
3. I_{SD} ≤ 7.5A di/dt ≤ 100A/us, V_{DD} ≤ BV_{DSS}, Starting T_J = 25°C
4. Pulsed Test : Pulsed width ≤ 300us, Duty cycle ≤ 2%
5. Essentially independent of operating temperature

Typical Characteristics

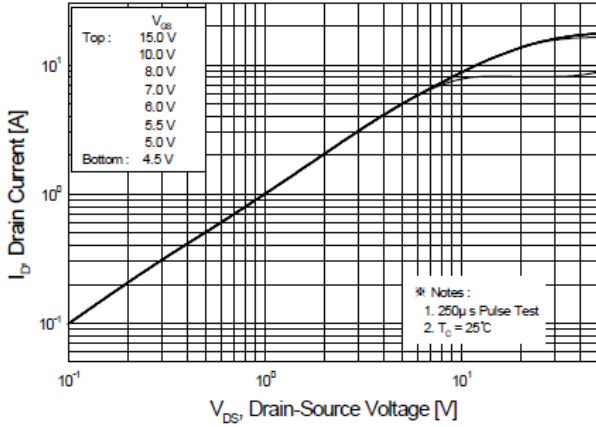

Figure 1. On-Region Characteristics

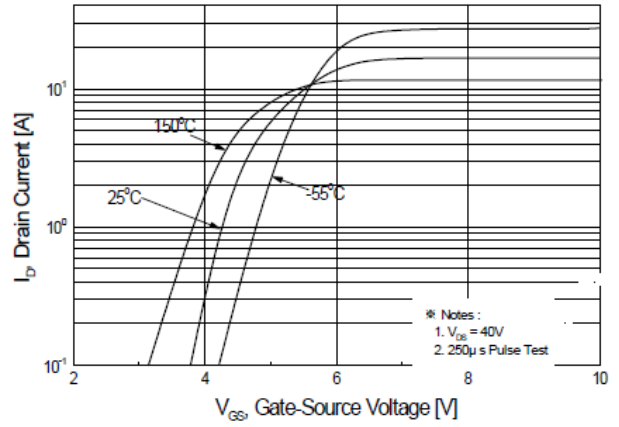

Figure 2. Transfer Characteristics

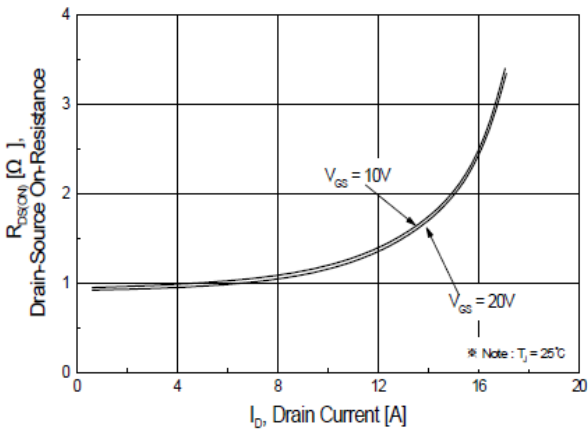

Figure 3. On-Resistance Variation vs Drain Current and Gate Voltage

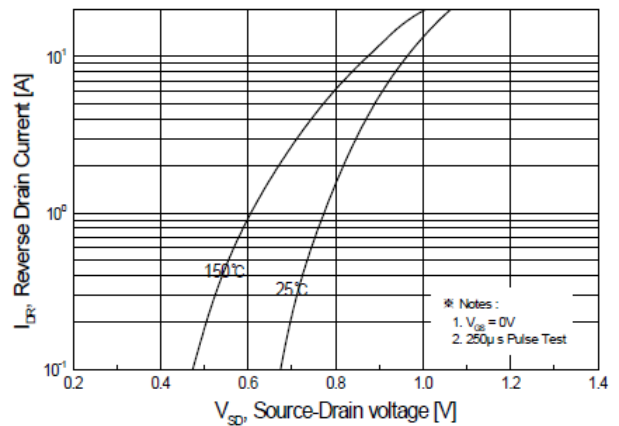

Figure 4. Body Diode Forward Voltage Variation with Source Current and Temperature

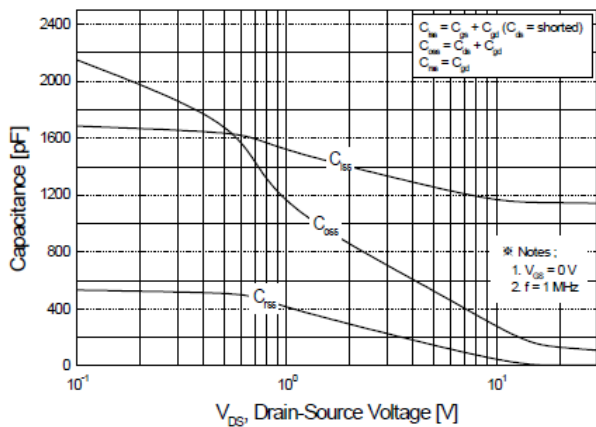

Figure 5. Capacitance Characteristics

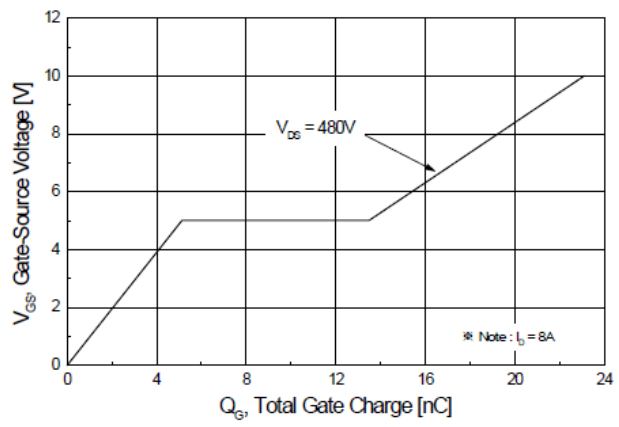

Figure 6. Gate Charge Characteristics

Typical Characteristics

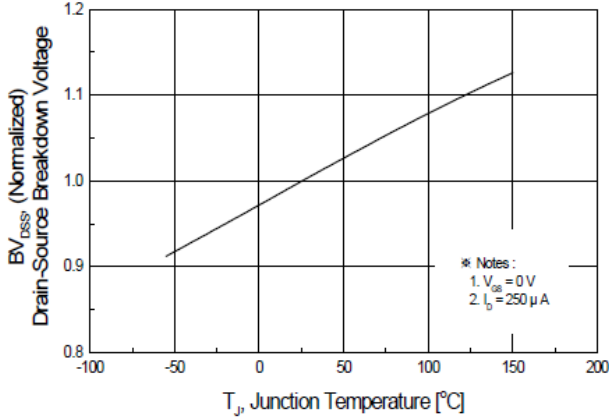

Figure 7. Breakdown Voltage Variation vs Temperature

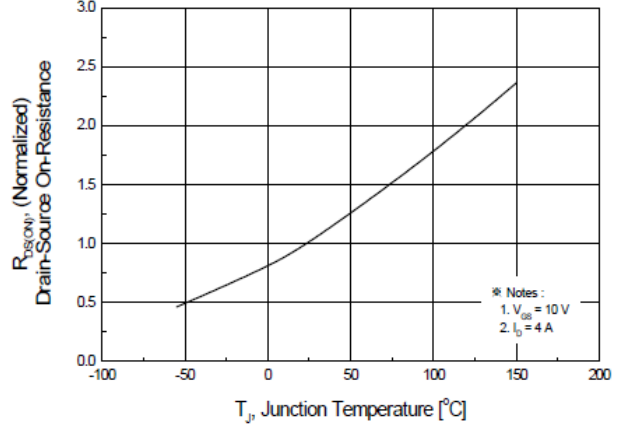

Figure 8. On-Resistance Variation vs Temperature

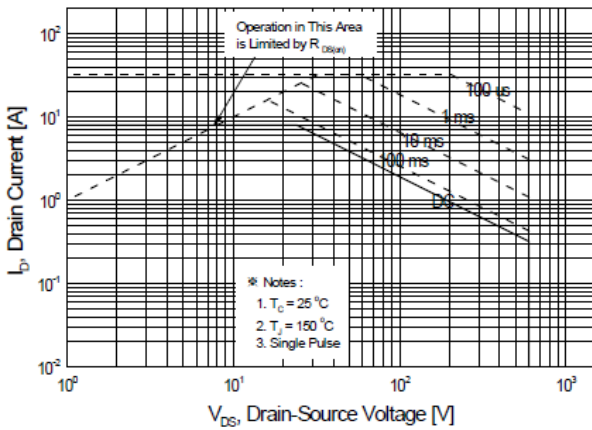

Figure 9-1. Maximum Safe Operating Area for JFPC7N60C

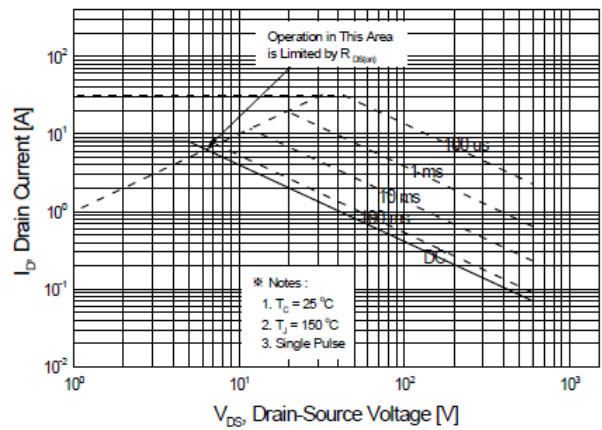

Figure 9-2. Maximum Safe Operating Area for JFFM7N60C

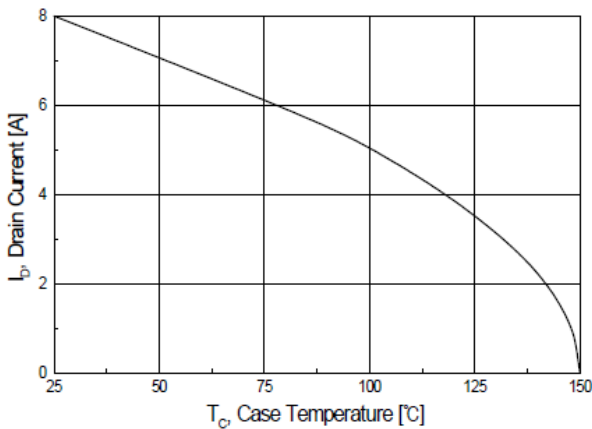
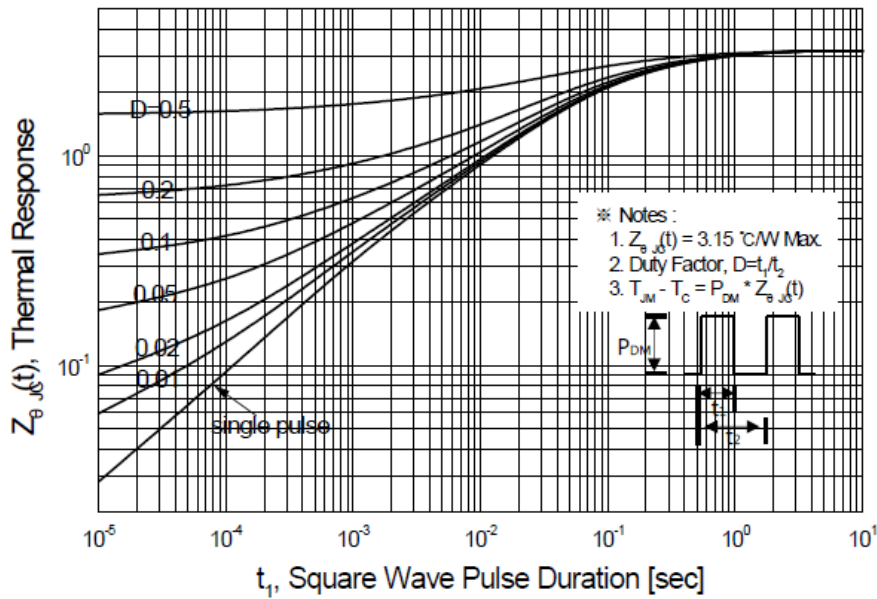
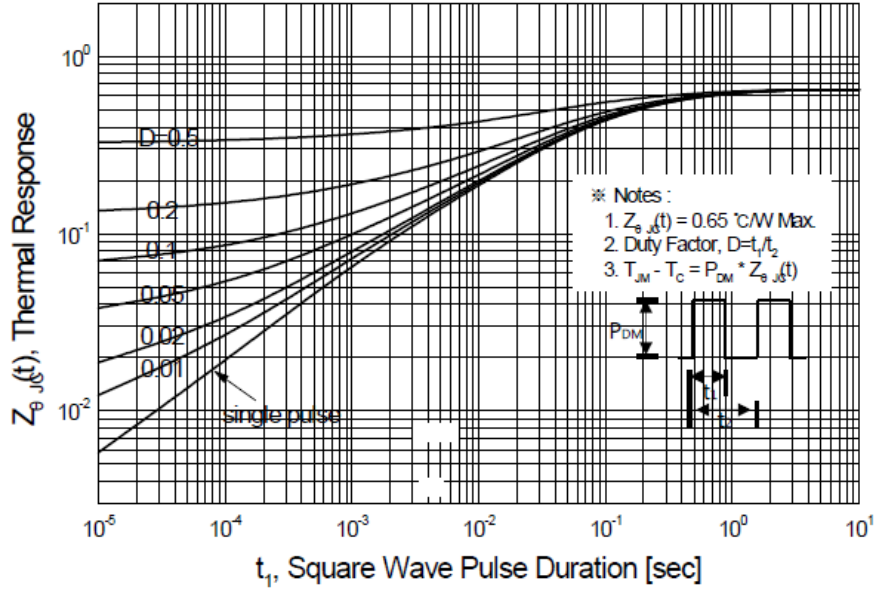
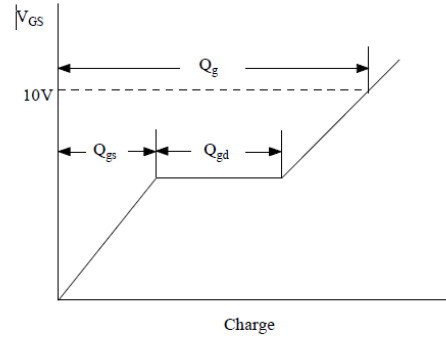
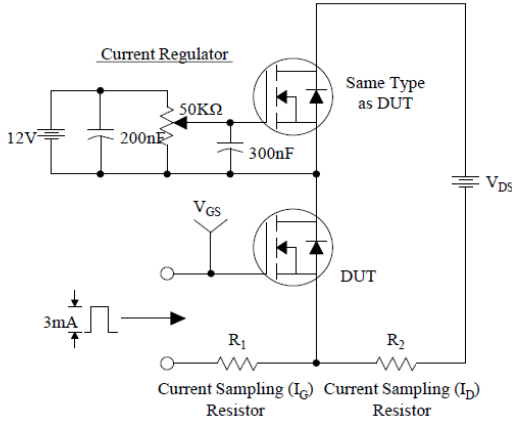

Figure 10. Maximum Drain Current vs Case Temperature

Typical Characteristics



Test Circuit & Waveform



Gate Charge Test Circuit & Waveform

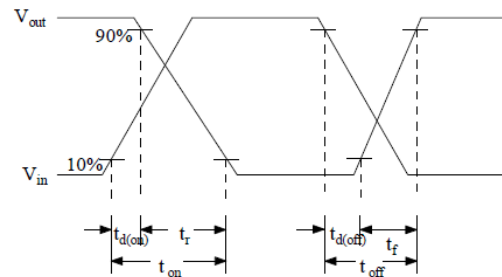
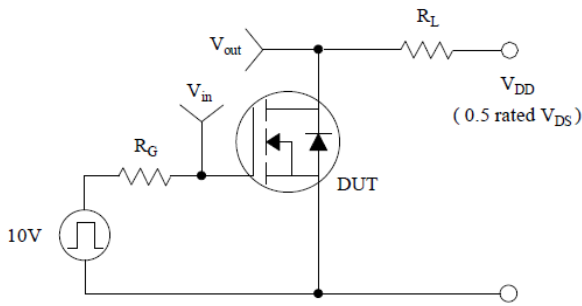

Resistive Switching Test Circuit & Waveforms

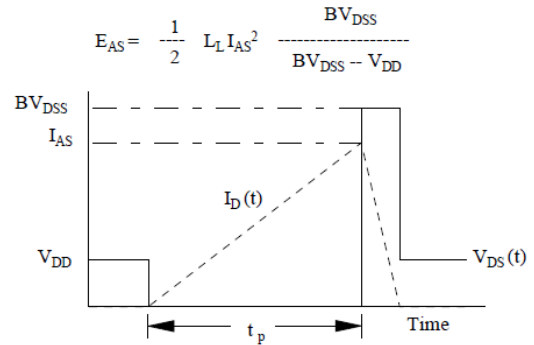
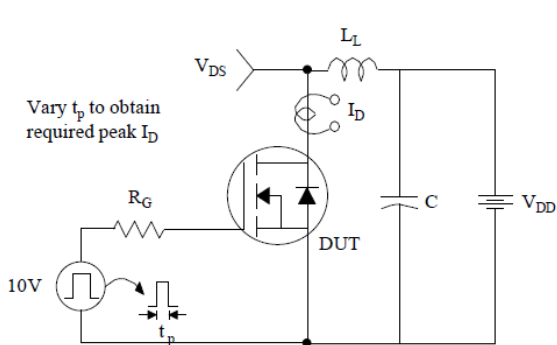

Unclamped Inductive Switching Test Circuit & Waveforms

Test Circuit & Waveform

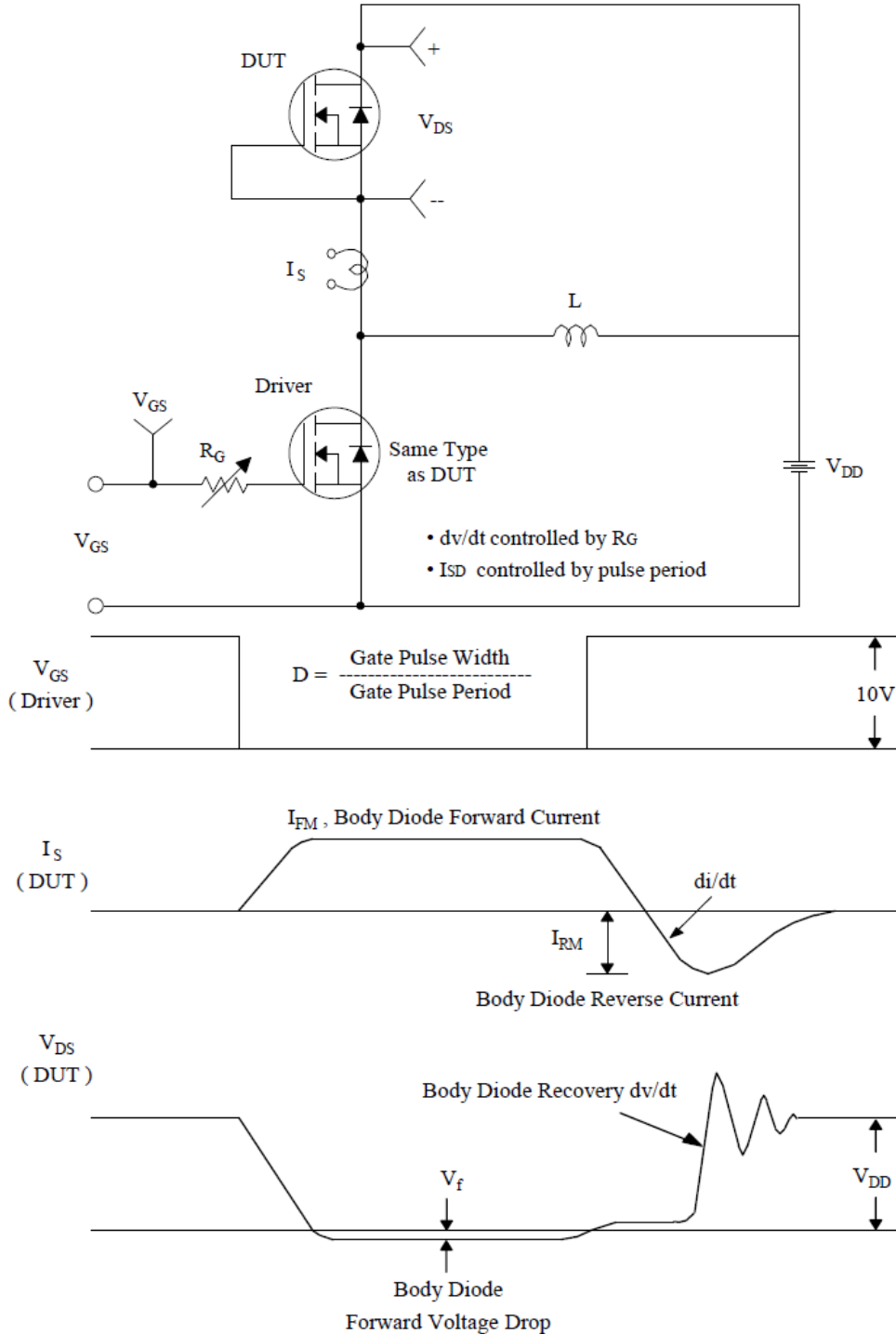

Peak Diode Recovery dv/dt Test Circuit & Waveforms